



**Audio System Upgrade Package**  
**2007-UP Dodge Avenger (Non Convertible Only)**  
**2007-2010 Chrysler Sebring (Non Convertible Only)**  
**2009-UP Dodge Ram Truck**  
**2011-UP Chrysler 200**  
**2011-UP Chrysler 300 Base Audio**  
**2011-UP Dodge Charger Base Audio**  
**2014-Up Jeep Cherokee (Six Speaker Base Audio)**  
**Installation Instructions**

**CONTENTS:**

**2EA. 6X9 WOOFER**  
**2EA. 1" DOME TWEETER**  
**1EA. INSTRUCTIONS**  
**8EA. #8X1" SCREW**

**P/N RW0869W**  
**P/N 05029827AB**  
**P/N RBI77KICK28AB**  
**P/N RFS81P**

**TOOLS REQUIRED:**

**Torx® T-20 Screwdriver**  
**Ratchet**  
**Torx® T-20 Socket**  
**Panel Removal Tool**  
**Pick Tool**  
**Phillips Screwdriver**

**Front Door Installation for Avenger and Sebring**

- 1. Disconnect negative battery cable.**
- 2. Remove the triangle shaped plastic panel at the top of the door by prying loose with a panel removal tool. Fig. 1**
- 3. Using a pick tool pry the screw cover behind the door latch release lever and remove the screw. Fig. 2**





**Audio System Upgrade Package**  
**2007-UP Dodge Avenger (Non Convertible Only)**  
**2007-2010 Chrysler Sebring (Non Convertible Only)**  
**2009-UP Dodge Ram Truck**  
**2011-UP Chrysler 200**  
**2011-UP Chrysler 300 Base Audio**  
**2011-UP Dodge Charger Base Audio**  
**2014-Up Jeep Cherokee (Six Speaker Base Audio)**  
**Installation Instructions**

4. Using a pick tool pry the screw cover in the door armrest pocket loose to reveal the two screws. The screw cover is hinged toward the outside of the door panel. Remove the two screws. Fig. 3
5. Using a panel removal tool gently pry the door panel away from the door. Fig. 4

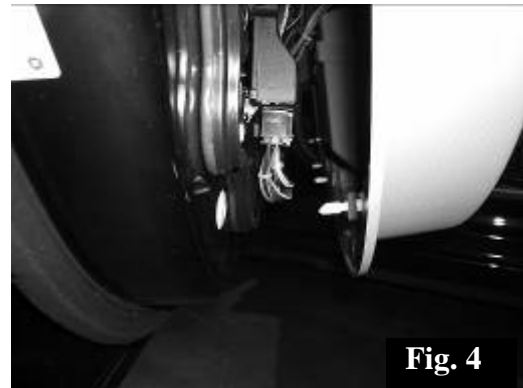

6. Disconnect the door handle linkage by rotating the plastic latch and pulling the linkage cable loose from the lever. Next, pull back on the cable housing and slide the cable through the slot in the plastic. Fig. 5
7. Disconnect door wiring and set door panel aside.
8. Using a Torx T-20 driver remove the four screws securing the speaker, disconnect wiring and remove speaker.
9. Install the upgrade speaker with the included spacer ring (P/N RISPACER), using the supplied 1” Phillips head screws and tighten. Fig. 6
10. Replace all previously removed parts in reverse order.

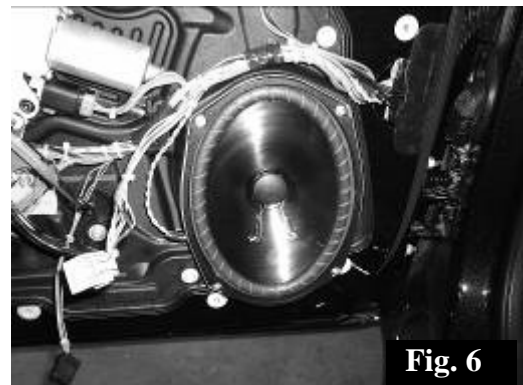
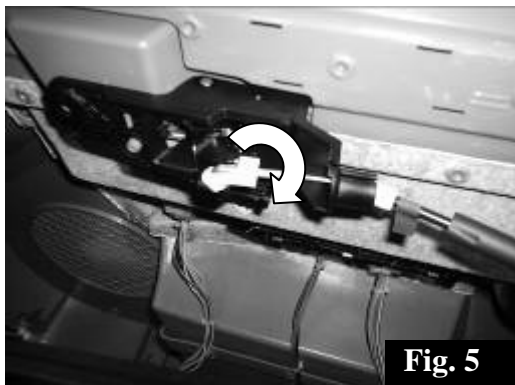



**Audio System Upgrade Package**  
**2007-UP Dodge Avenger (Non Convertible Only)**  
**2007-2010 Chrysler Sebring (Non Convertible Only)**  
**2009-UP Dodge Ram Truck**  
**2011-UP Chrysler 200**  
**2011-UP Chrysler 300 Base Audio**  
**2011-UP Dodge Charger Base Audio**  
**2014-Up Jeep Cherokee (Six Speaker Base Audio)**  
**Installation Instructions**

**Dash Speaker Installation Sebring**

11. Using a panel removal tool gently pry the speaker grills upward to release retainers. Fig. 7
12. Remove the Torx® T-20 screws securing the existing speakers disconnect wiring and remove speaker. Fig. 8

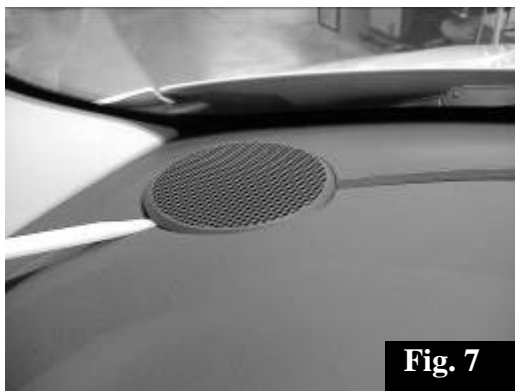

**Fig. 7**

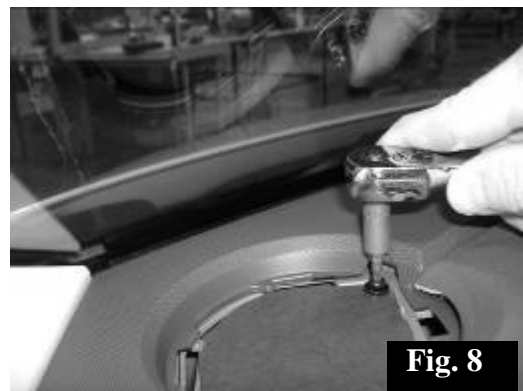

**Fig. 8**

13. Connect the speaker wiring install the upgrade speaker and replace screws
14. Replace speaker grills.

**Dash Speaker Installation Avenger**

15. Using a panel removal tool gently pry the speaker grills upward to release retainers. Fig. 9
16. Remove the Torx® T-20 screws securing the existing speakers disconnect wiring and remove speaker
17. Connect the speaker wiring install the upgrade speaker and replace screws. Fig. 10
18. Replace speaker grills.



**Fig. 9**



**Fig. 10**



**Audio System Upgrade Package**  
**2007-UP Dodge Avenger (Non Convertible Only)**  
**2007-2010 Chrysler Sebring (Non Convertible Only)**  
**2009-UP Dodge Ram Truck**  
**2011-UP Chrysler 200**  
**2011-UP Chrysler 300 Base Audio**  
**2011-UP Dodge Charger Base Audio**  
**2014-Up Jeep Cherokee (Six Speaker Base Audio)**  
**Installation Instructions**

**Dodge Truck Door Speaker Installation**

**TOOLS REQUIRED:**

**Phillips Screwdriver**  
**Panel Removal Tool**  
**Pick Tool**  
**Torx®T20**  
**7mm Socket**  
**Ratchet**

1. **Disconnect negative battery cable.**
2. **Using a pick tool pry open the screw covers behind the interior door release lever. Fig. 11**
3. **Using a Phillips screwdriver remove the screw behind the screw cover. Fig. 12**



4. **Using a panel removal tool snap loose the door release bezel. Fig. 13**
5. **Remove six Torx®T20 retainers by unscrewing the center and then pulling out the entire retainer. Fig. 14**





**Audio System Upgrade Package**  
**2007-UP Dodge Avenger (Non Convertible Only)**  
**2007-2010 Chrysler Sebring (Non Convertible Only)**  
**2009-UP Dodge Ram Truck**  
**2011-UP Chrysler 200**  
**2011-UP Chrysler 300 Base Audio**  
**2011-UP Dodge Charger Base Audio**  
**2014-Up Jeep Cherokee (Six Speaker Base Audio)**  
**Installation Instructions**

---

6. Using a panel removal tool snap loose upper trim panel. Fig. 15
7. Lift up on door panel to release.
8. Disconnect window switch by pushing switch out from rear, then unplug. Fig. 16



9. Remove four 5mm screws securing the speaker, disconnect wiring and remove speaker. Fig. 17
10. Install upgrade speaker, replace screws, and tighten.



11. Replace all previously removed parts in reverse order.
12. Repeat for other side of vehicle.



**Audio System Upgrade Package**  
**2007-UP Dodge Avenger (Non Convertible Only)**  
**2007-2010 Chrysler Sebring (Non Convertible Only)**  
**2009-UP Dodge Ram Truck**  
**2011-UP Chrysler 200**  
**2011-UP Chrysler 300 Base Audio**  
**2011-UP Dodge Charger Base Audio**  
**2014-Up Jeep Cherokee (Six Speaker Base Audio)**  
**Installation Instructions**

---

**Dodge Truck Dash Speaker Installation**

- 13. Using a panel removal tool. Remove the grills for both dash speakers. Fig. 18**  
**14. Remove the 7mm screws securing the speaker, disconnect wiring and remove speaker. Fig. 19**



**Fig. 18**



**Fig. 19**

- 15. Install the upgrade speaker. Replace screws and tighten. Fig. 20**  
**16. Repeat steps 13 and 14 for other side.**



**Fig. 20**

- 17. Reinstall all previously removed parts in reverse order.**



**Audio System Upgrade Package**  
**2007-UP Dodge Avenger (Non Convertible Only)**  
**2007-2010 Chrysler Sebring (Non Convertible Only)**  
**2009-UP Dodge Ram Truck**  
**2011-UP Chrysler 200**  
**2011-UP Chrysler 300 Base Audio**  
**2011-UP Dodge Charger Base Audio**  
**2014-Up Jeep Cherokee (Six Speaker Base Audio)**  
**Installation Instructions**

**Front Door Installation 2011 Chrysler 200**

1. Remove the triangle shaped plastic panel at the top of the door by prying loose with a panel removal tool. Fig. 21
2. Using a pick tool pry the screw cover behind the door latch release lever and remove the Torx® T-20 screw. Fig. 22



3. Using a pick tool pry the screw cover in the door armrest pocket loose to reveal and remove the two Torx® T-20 screws. Fig. 23
4. Using a panel removal tool gently pry the door panel away from the door. Fig. 24

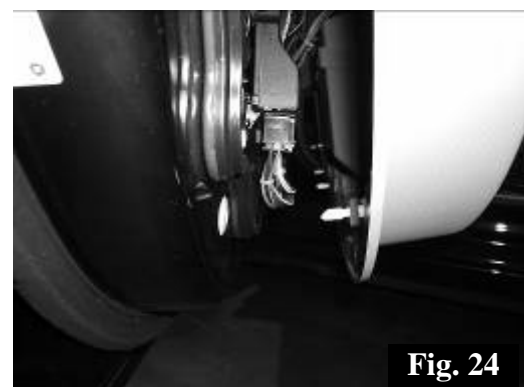
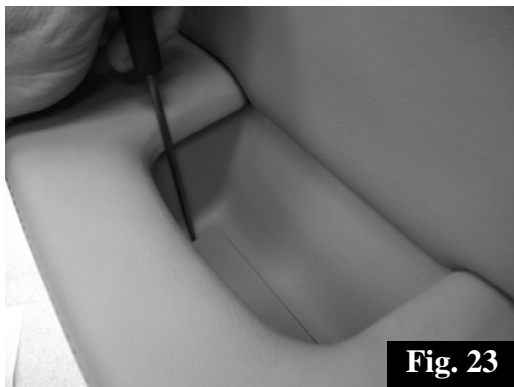



**Audio System Upgrade Package**  
**2007-UP Dodge Avenger (Non Convertible Only)**  
**2007-2010 Chrysler Sebring (Non Convertible Only)**  
**2009-UP Dodge Ram Truck**  
**2011-UP Chrysler 200**  
**2011-UP Chrysler 300 Base Audio**  
**2011-UP Dodge Charger Base Audio**  
**2014-Up Jeep Cherokee (Six Speaker Base Audio)**  
**Installation Instructions**

5. Disconnect door wiring and move the door panel aside enough to allow access to the speaker. Leave door handle linkage attached.
6. Using a Torx T-20 driver remove the four screws securing the speaker, disconnect wiring and remove speaker.
7. Install the upgrade speaker with the included spacer ring (P/N RISPACER), using the supplied 1” Phillips head screws and tighten. Fig. 25
8. Replace all previously removed parts in reverse order.

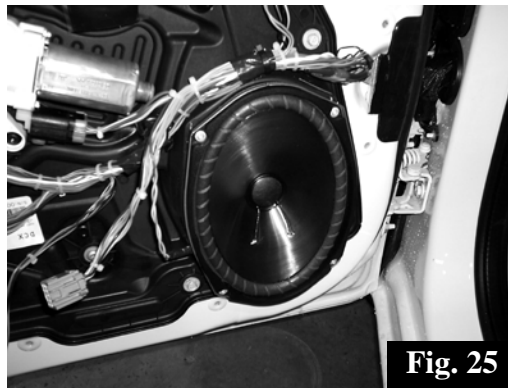

**2011-UP Charger,300 Dash Speaker Installation**

1. Pull the rubber door molding away from the A pillar location on driver’s side and passenger’s side. Fig. 26
2. Pull the A pillar cover loose on the driver’s side and passenger’s side and disconnect the black retainer. Fig. 27







**Audio System Upgrade Package**  
**2007-UP Dodge Avenger (Non Convertible Only)**  
**2007-2010 Chrysler Sebring (Non Convertible Only)**  
**2009-UP Dodge Ram Truck**  
**2011-UP Chrysler 200**  
**2011-UP Chrysler 300 Base Audio**  
**2011-UP Dodge Charger Base Audio**  
**2014-Up Jeep Cherokee (Six Speaker Base Audio)**  
**Installation Instructions**

3. Using a panel removal tool, gently lift speaker grill to release fasteners. Fig. 28
4. Remove the 7mm screws securing the existing speakers disconnect wiring and remove speaker
5. Connect the speaker wiring install the upgrade speaker and replace screws. Fig. 29

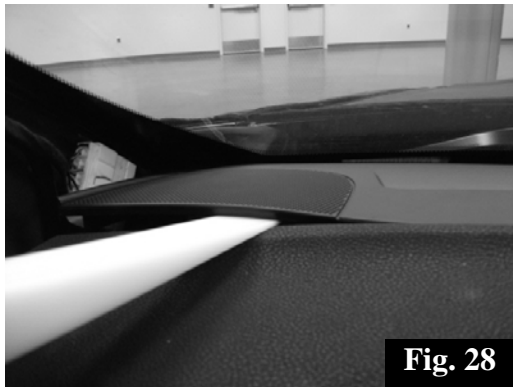

**Fig. 28**



**Fig. 29**

**2011-UP Charger, 300 Front Door Speakers**

6. Using the end of a Phillips screwdriver gently depress the center pin of the plastic retainer toward the front of the door panel. The center pin of the plastic retainer should depress approximately 1/8" to allow the retainer to be removed from the door panel and then pry out with a panel removal tool. Fig. 30
7. Using a pick tool, remove the screw cover behind the door release lever and the armrest and remove the screws. Fig. 31



**Fig. 30**



**Fig. 31**



**Audio System Upgrade Package**  
**2007-UP Dodge Avenger (Non Convertible Only)**  
**2007-2010 Chrysler Sebring (Non Convertible Only)**  
**2009-UP Dodge Ram Truck**  
**2011-UP Chrysler 200**  
**2011-UP Chrysler 300 Base Audio**  
**2011-UP Dodge Charger Base Audio**  
**2014-Up Jeep Cherokee (Six Speaker Base Audio)**  
**Installation Instructions**

---

8. Remove the screw retaining the rubber bumper. Fig. 32
9. Using a panel removal tool pry loose the switch plate and disconnect the wiring. Fig. 33



10. Snap loose the door panel using a panel removal tool and disconnect wiring.
11. Remove the four screws securing the speaker, disconnect wiring and remove speaker.
12. Install the upgrade speaker and replace screws. Fig. 34
13. For reassembly, remove the window felt by releasing the four metal clips securing it to the door panel. Reinstall the window felt onto metal along the top of the door and then reinstall the door panel in reverse order. Fig. 35





**Audio System Upgrade Package**  
**2007-UP Dodge Avenger (Non Convertible Only)**  
**2007-2010 Chrysler Sebring (Non Convertible Only)**  
**2009-UP Dodge Ram Truck**  
**2011-UP Chrysler 200**  
**2011-UP Chrysler 300 Base Audio**  
**2011-UP Dodge Charger Base Audio**  
**2014-Up Jeep Cherokee (Six Speaker Base Audio)**  
**Installation Instructions**

## Jeep Cherokee

### Instrument Panel Speaker

1. Disconnect and isolate the negative battery cable.
2. Using a non-marring panel removal tool, remove the speaker grille from the top of the instrument panel.
3. Remove the two fasteners (1) securing the speaker (2) to the instrument panel.
4. Lift the speaker up and disconnect the wiring harness.
5. Remove the speaker from the vehicle.
6. Connect replacement speaker and reinstall in reverse order.
7. Repeat steps 2-6 for other instrument panel speaker.

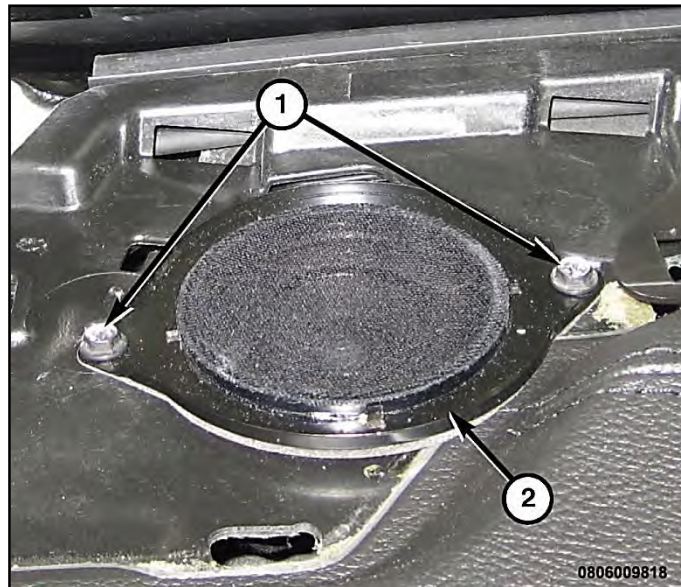

### Front Door Speaker

8. Using a non-marring panel removal tool, remove and disconnect the window switch (1) from the door.
9. Using a non-marring panel removal tool, remove the liner (4) from the door trim pull handle.
10. Remove the fastener (3) securing the door trim panel to the carrier plate.

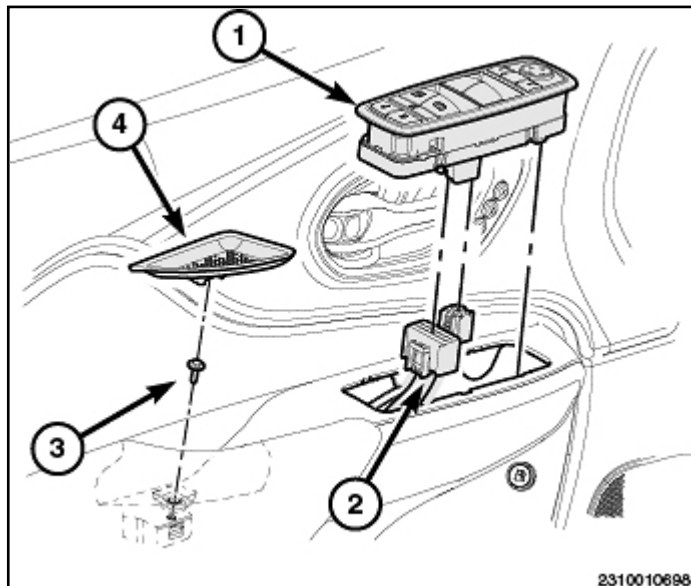



**Audio System Upgrade Package**  
**2007-UP Dodge Avenger (Non Convertible Only)**  
**2007-2010 Chrysler Sebring (Non Convertible Only)**  
**2009-UP Dodge Ram Truck**  
**2011-UP Chrysler 200**  
**2011-UP Chrysler 300 Base Audio**  
**2011-UP Dodge Charger Base Audio**  
**2014-Up Jeep Cherokee (Six Speaker Base Audio)**  
**Installation Instructions**

11. Using a non-marring panel removal tool, pull out on the interior door handle and remove the bezel (2) located in the cavity.
12. Remove the fastener (1) and the fastener securing the door trim panel to the carrier plate.

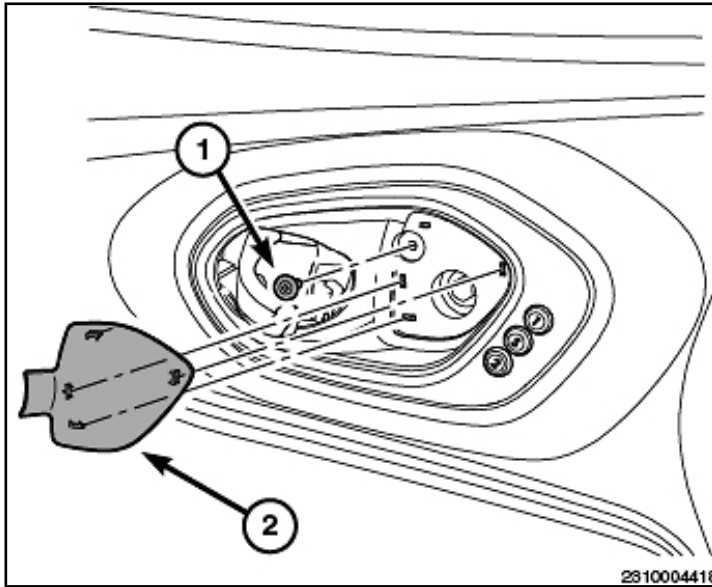

13. Using a non-marring panel removal tool, pry the door trim panel away from the door (1) starting along the lower edge and working around the perimeter to disengage the retaining clips (3).

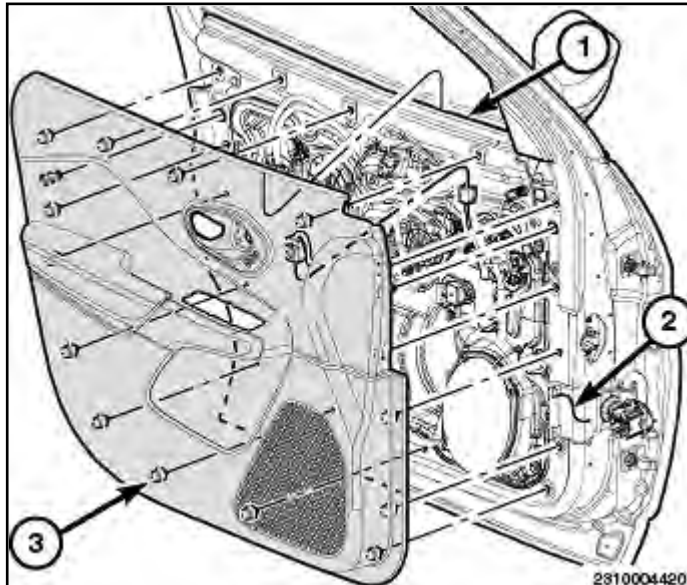



**Audio System Upgrade Package**  
**2007-UP Dodge Avenger (Non Convertible Only)**  
**2007-2010 Chrysler Sebring (Non Convertible Only)**  
**2009-UP Dodge Ram Truck**  
**2011-UP Chrysler 200**  
**2011-UP Chrysler 300 Base Audio**  
**2011-UP Dodge Charger Base Audio**  
**2014-Up Jeep Cherokee (Six Speaker Base Audio)**  
**Installation Instructions**

14. Lift the door trim panel up and out. **Position the door trim panel slightly away, do not remove.**
15. Pull the interior handle (1) out fully from the notch (2) to detach from the trim panel (3).
16. Disconnect electrical connectors and remove the door trim panel (3).

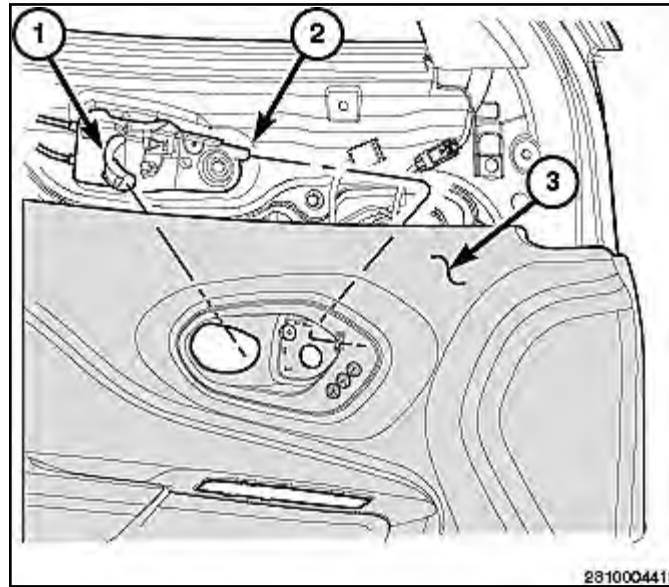

17. Remove the mounting fasteners (1).
18. Remove the speaker (2) from the door.
19. Disconnect the wire harness connector from the speaker
20. Connect replacement speaker and reinstall in reverse order.
21. Repeat steps 8-20 for other door speaker.

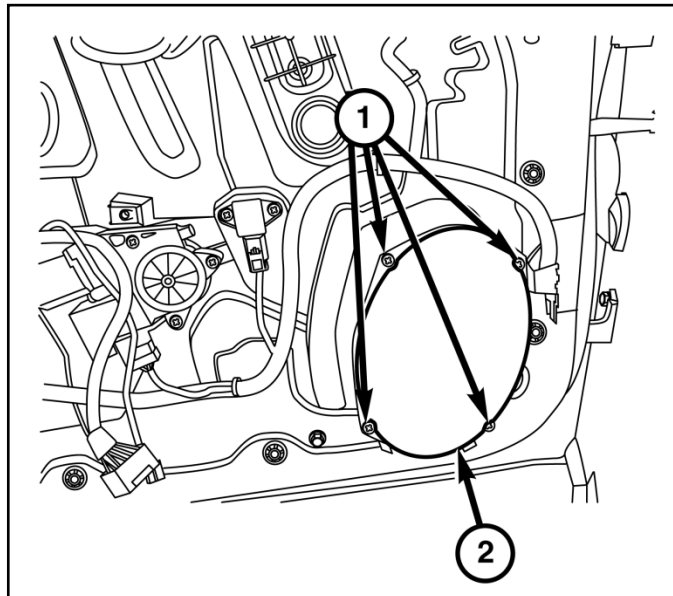

22. Replace all previously removed trim panels in reverse order.
23. Reconnect negative battery cable.